



# Clea connect

The next generation smart timer that ends the era of mechanical timers!



## Why recommend Clea to your clients?

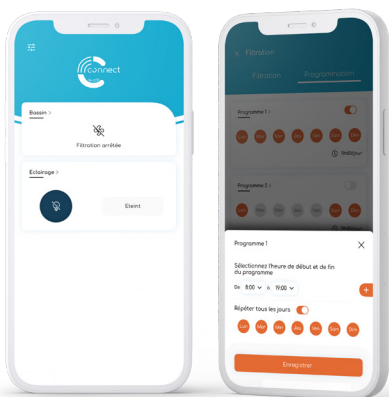

**Effortless installation:** directly replace the old mechanical standard timer.



**Compact design:** save space inside the electrical panel, fits even in tight ones



**Ideal for renovation:** compatible with old panel, making it perfect for upgrades



**Precise and reliable:** automatically syncs with the smartphone's time and includes a quartz backup battery to maintain settings during power outages.

## The end of mechanical timers!

**Say goodbye to outdated pin timers!** Clea installs in one minute thanks to its plug & play system. It snaps directly into the electrical panel, replacing a mechanical timer no modifications needed, just few connections to a 230V power supply are all it takes.

## Control your pool with the Connect app!

### Filtration | Clea 1 et 2



How to use



ON/OFF

Start the filtration cycle manually

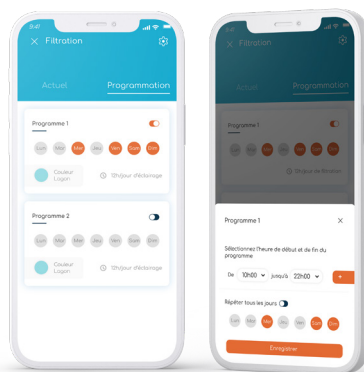

Programme your filtration for weekdays and weekends

### Lighting | Clea 2



**Monochrome**  
Compatible with all projectors

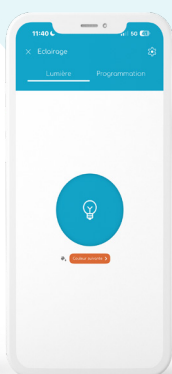

**Next colour**  
Change your colour easily

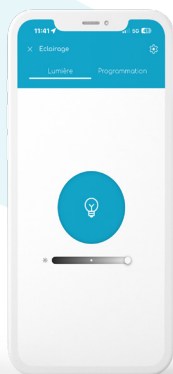

**Dimmable monochrome**  
Change colour easily

Lighting

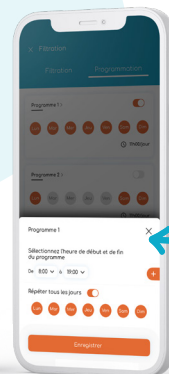
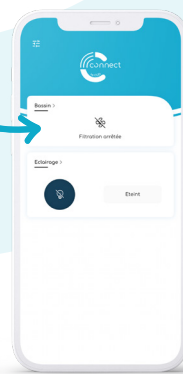

Filtration

## An easy upgrade for your clients



**Intuitive control via the CCEI Connect app**  
(available on iOS & Android)



**Quick setup means time saved**  
on every installation



**A modern, reliable, and cost-effective alternative**  
to traditional mechanical timers

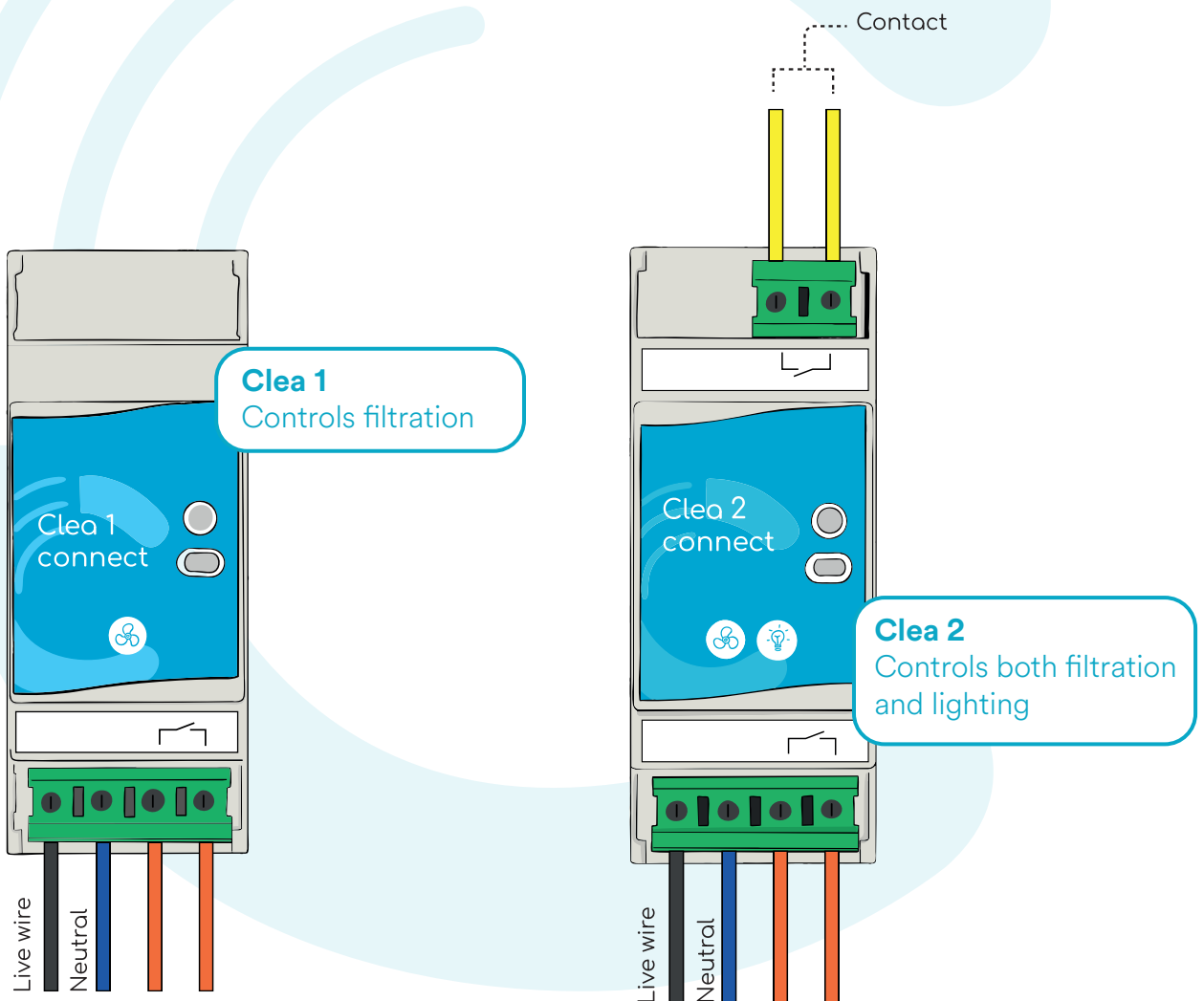
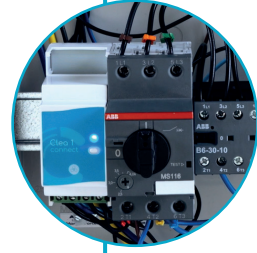

Reference	Alim	Dimensions	Features	Communication
PF10M400	230V	89,5 x 50 x 65 mm	Filtration	Bluetooth, local wifi
PF10M410	230V	89,5 x 50 x 65 mm	Filtration & lighting	Bluetooth, local wifi